

mySigen App

User Manual

Version: 03

Release date: 2024-05-17



Copyright Notice

Copyright© 2024 Sigenergy Technology Co., Ltd. All Rights Reserved.

Description in this document may contain predictive statements regarding financial and operating results, product portfolio, new technology, configurations and features of product. Several factors could cause difference between actual results and those expressed or implied in the predictive statements. Therefore, description in this document is provided for reference purpose only and constitutes neither an offer nor an acceptance. Sigenergy Technology Co., Ltd. may change the information at any time without notice.



SIGENERGY

and other Sigenergy trademarks are owned by Sigenergy Technology Co., Ltd.

All trademarks and registered trademarks in this document belong to their owners.



Website



LinkedIn



YouTube

www.sigenergy.com

Contents

Revision History	6
Overview	7
Chapter 1 Installing and Login	8
1.1 Downloading the App.....	8
1.2 App login.....	9
Chapter 2 Information querying	10
2.1 Power Station	10
2.1.1 Operation Information.....	10
2.1.2 Operation Information of a Single Unit.....	11
2.1.3 Alarm information	12
2.2 Sigen EV AC Charger	13
2.2.1 Operation Information.....	13
2.2.2 Alarm information	14
2.2.3 Charging Records	15
2.3 Warranty Information	16
2.4 App Version.....	16
Chapter 3 Parameter setup	17
3.1 Station diagnosis.....	17
3.2 Setting rate plan	18
3.3 Editing station type, name, and address.....	18
3.4 Energy storage working mode.....	19

3.4.1 Sigen AI Mode.....	20
3.4.2 Self-Consumption Mode.....	21
3.4.3 Time-based Control Mode.....	23
3.4.4 Fully Fed to Grid	27
3.5 Backup power setup.....	28
3.6 Internet connection.....	30
3.7 LED status setup.....	31
3.8 On-grid/Off-grid switchover.....	32
3.9 Adding device	34
3.9.1 Third-party inverter.....	35
3.9.2 Diesel generator.....	37
3.9.3 Smart load.....	39
3.10 Device power-on/off	41
3.11 Sigen EV AC Charger Parameters	43
3.11.1 Binding RFID card.....	43
3.11.2 Charging/Stop Charging Settings.....	43
3.11.3 Charging Current Adjustment.....	44
3.11.4 Modifying output mode.....	46
3.12 App Parameters	47
3.12.1 Upgrading mySigen.....	47
3.12.2 Changing password	48
3.12.3 Configuring parameters on the "App Setting" screen.....	49

Chapter 4 Switch Accounts 51

Chapter 5 Changing Email Account.....52

Chapter 6 Support 53

Chapter 7 Logout 54

Chapter 8 FAQs 55

8.1 What should I do if I do not receive the email (link, password change) sent by the system?55

8.2 In grid connection scenarios, how can I quickly identify where SigenStor is installed?55

Revision History

Version	Date	Description
03	2024.05.17	<ul style="list-style-type: none"> ● Updated Chapter 2 Information querying. ● Added 3.1 Station diagnosis. ● Added 3.2 Setting rate plan. ● Added 3.3 Editing station type, name, and address. ● Updated 3.4 Energy storage working mode. ● Updated 3.6 Internet connection. ● Updated 3.7 LED status setup. ● Added 3.8 On-grid/Off-grid switchover. ● Added 3.9 Adding device. ● Updated 3.11.3 Charging Current Adjustment. ● Added 3.11.4 Modifying output mode. ● Added Chapter 5 Changing Email Account. ● Added 8.2 In grid connection scenarios, how can I quickly identify where SigenStor is installed?
02	2024.01.15	<ul style="list-style-type: none"> ● Updated Chapter 2 Information querying. ● Updated Chapter 3 Parameter setup. ● Added Chapter 4 Switch Accounts. ● Added Chapter 6 Support.
01	2023.09.11	Initial release.

Overview

Introduction

This document describes how to use the mySigen App.



Readers

This document is intended for:

Users

Sign Definition

The following signs may be used in the document to indicate security precautions or key information. Before installation and operation, familiarize yourself with signs and their definitions.

Signs	Definition
 Danger	Danger. Failure to comply may result in death or serious personal injury.
 Warning	Warning. Failure to comply may result in serious personal injury or property damage.
 Caution	Caution. Failure to comply will result in property damage.
Tips	Important or key information, and supplementary operation tips.

Chapter 1 Installing and Login

1.1 Downloading the App

Requirements for mobile OS:

To guarantee stable functioning, we recommend that your mobile phones run on Android OS 6.0, iOS 12.0, or later versions.

You can download the App using the following two methods:

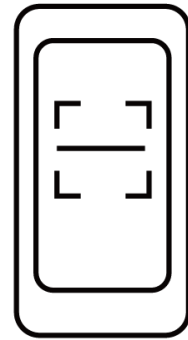

SSA1CM00014

This document takes version 1.9.0 as an example to introduce relevant operations.

1.2 App login

Sign up:

1. Provide your email account to the installer for signing up.
2. After signing up your account, the installer will ask you to activate your account.
3. Please check the email sent from the "sigencloud" account in your inbox, set your initial password, and activate your account.

Login:

Enter your account and password and click "Log in".

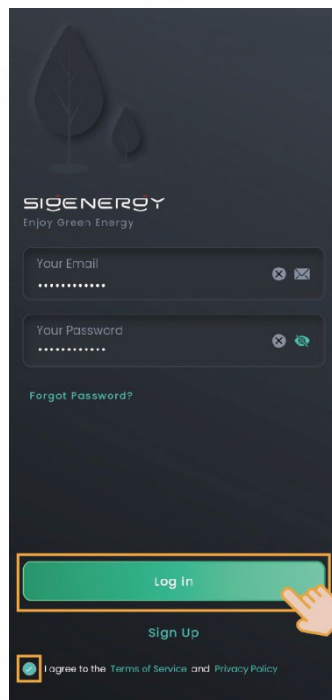

SSA1CM00002

Chapter 2 Information querying

2.1 Power Station

2.1.1 Operation Information

The Home screen displays running information, including Diagnosis, Notice, Mode, Safety, and Lighting modules.

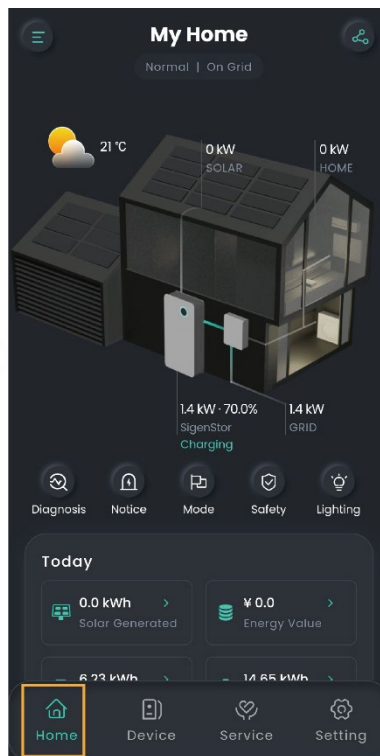

SSA1CM00003

You can click  to share information displayed on the Home screen to others.

2.1.2 Operation Information of a Single Unit

You can query running information of a single unit such as Gateway and Power Sensor using the following two methods.

Method 1: Click "Home" → product picture.

Method 2: Click "Device".

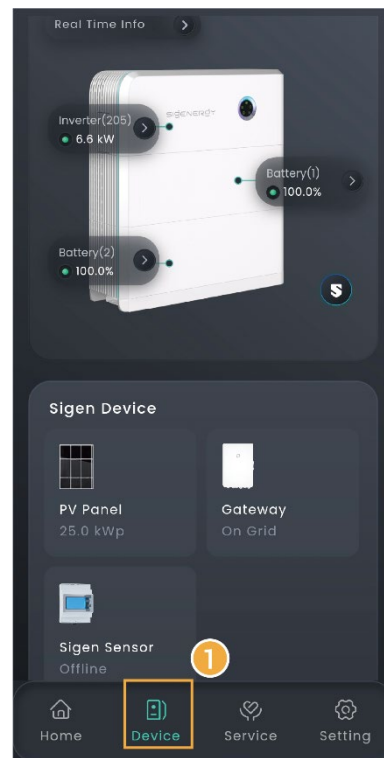
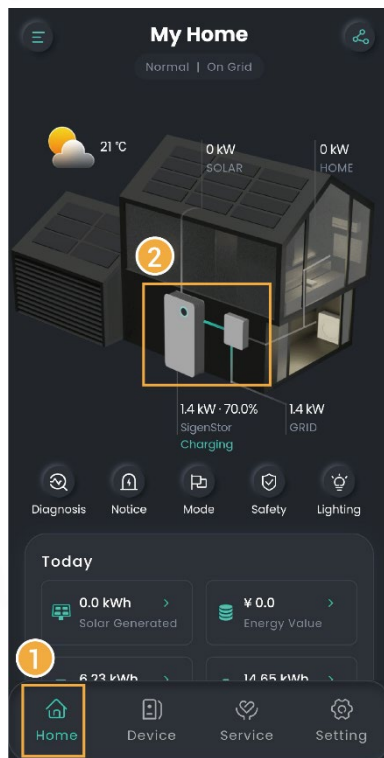

2.1.3 Alarm information

You can query alarm information using the following two methods.

Method 1: Click "Home" → "Notice".

Method 2: Click "Service" to view alarm information.

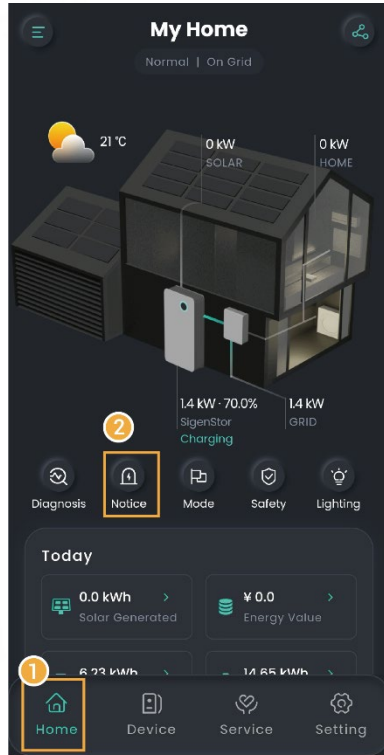

SSA1CM00003

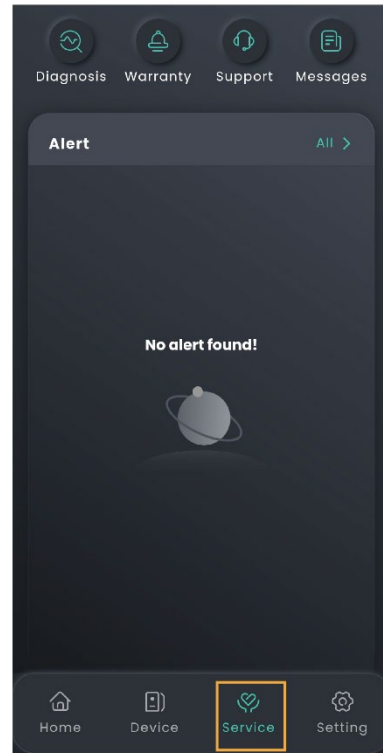

2.2 Sigen EV AC Charger

2.2.1 Operation Information

You can query operation information from "Energy Delivery" on the Home page.

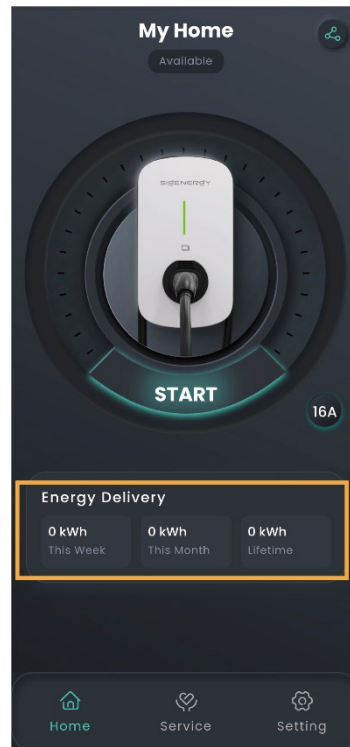

MSA1CM00037

You can click  to share information displayed on the Home screen to others.

2.2.2 Alarm information

Click "Service" to view.

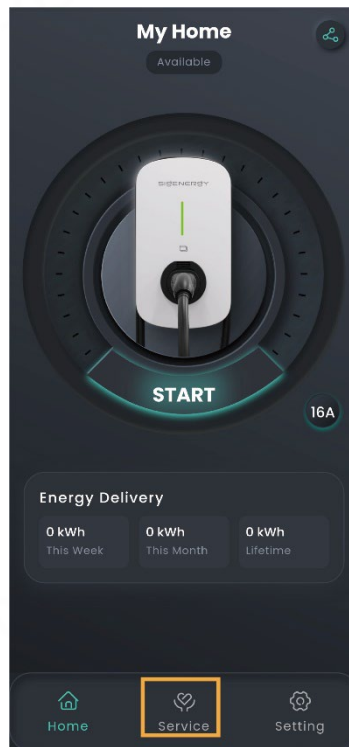

MSA1CM00037

2.2.3 Charging Records



MSA1CM00038

2.3 Warranty Information

Click "Service" → "Warranty" to view.

2.4 App Version

Click "Setting" → "About" to view the App version and other information.

Chapter 3 Parameter setup

3.1 Station diagnosis

You can use this feature to check the communication status of the station and connection status of devices in the station.

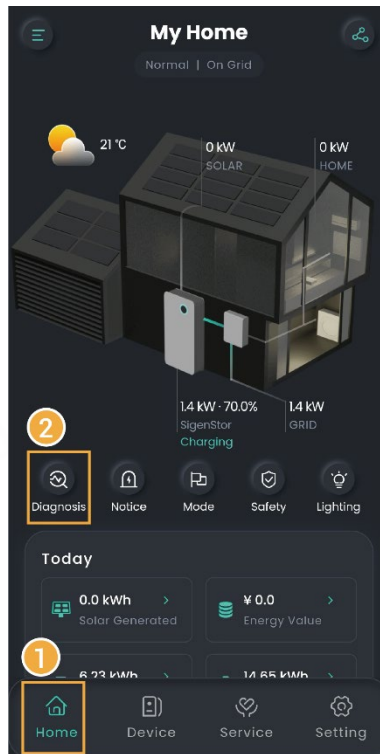

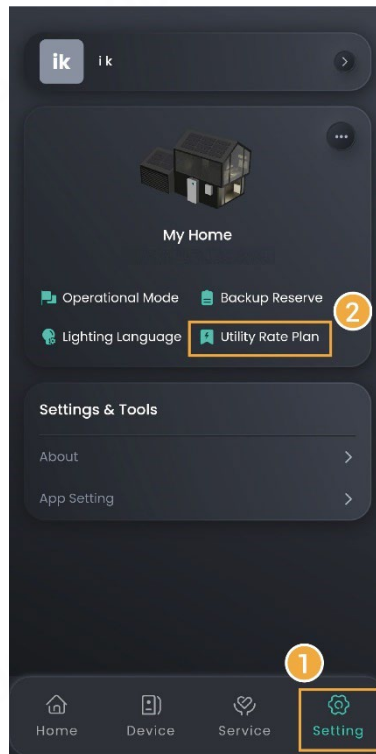

SSA1CM00003

3.2 Setting rate plan



MSA1CM00004

3.3 Editing station type, name, and address

Click "Setting" → . You can click  next to the item you want to edit to go to the editing screen.

3.4 Energy storage working mode

Tips

- **The energy storage system has four working modes, including Sigen AI Mode, Fully Fed to Grid Mode, Self-Consumption Mode, and Time-based Control Mode.**
- **The Sigen AI Mode is available in some countries and regions. The screen display shall prevail.**

You can set the working mode using the following two methods:

Method 1: Click "Home" → "Mode"

Method 2: "Setting" → "Operational Mode"

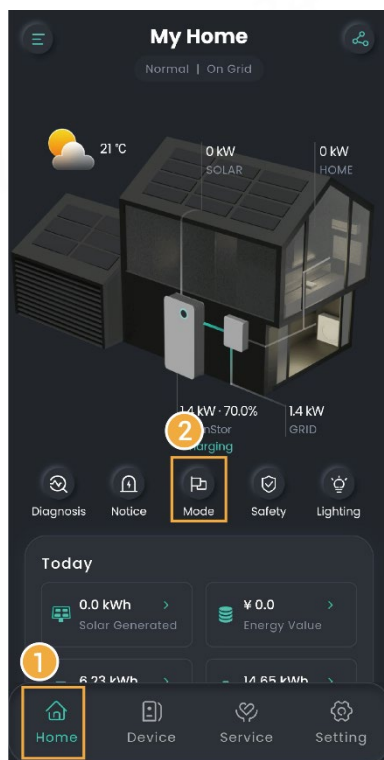

SSA1CM00003

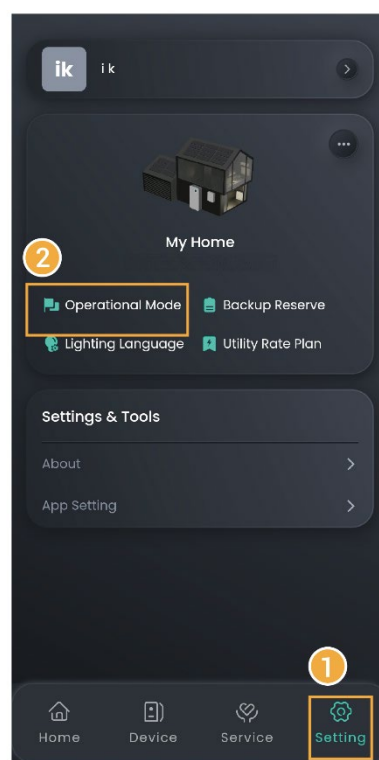

3.4.1 Sigen AI Mode

In Sigen AI Mode, the system records data such as electricity usage, local peak-valley electricity price, and weather conditions and thus customizes smart electricity solutions to save electricity costs for customers to the maximum extent.

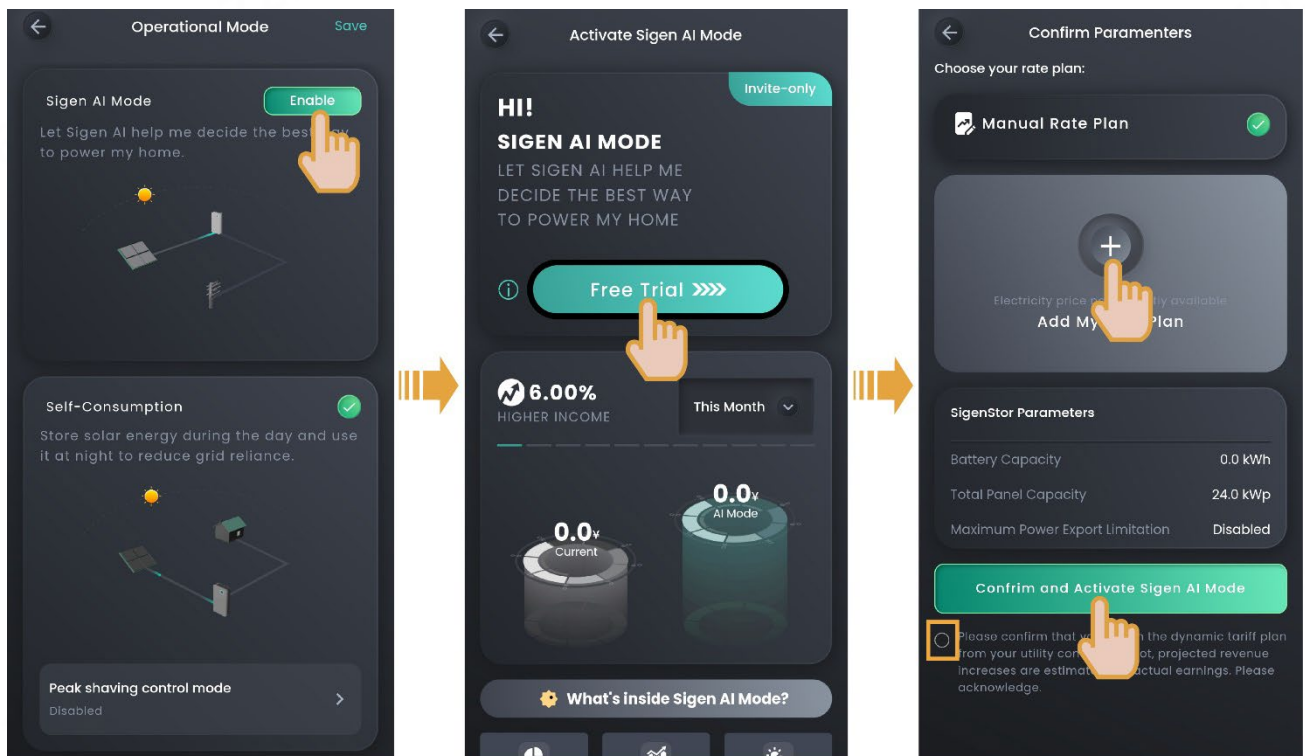
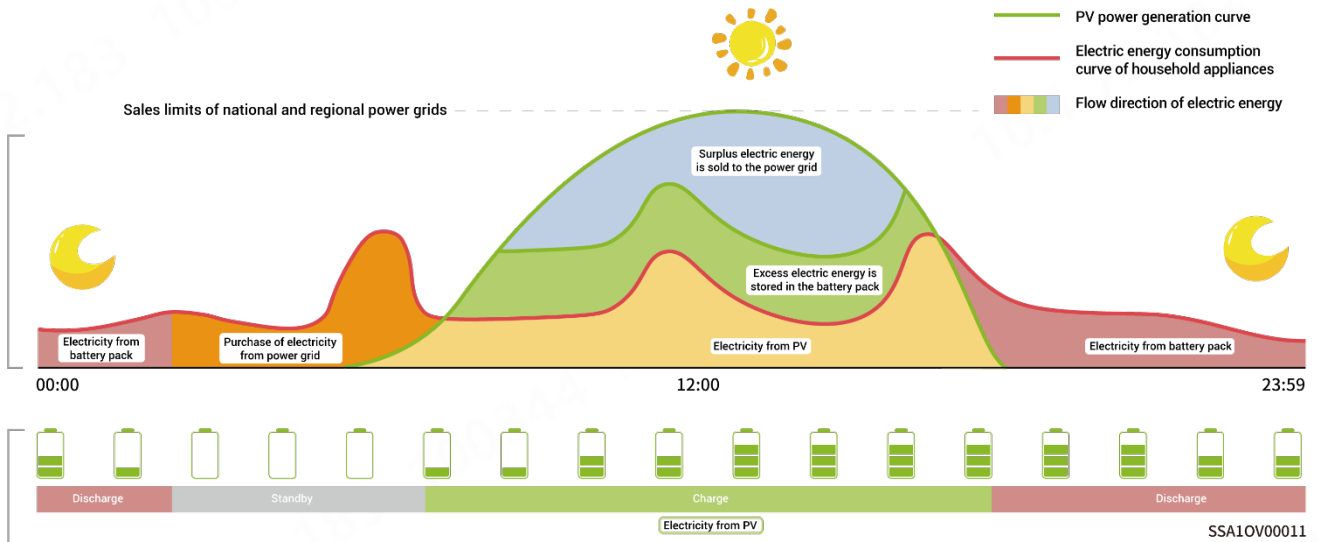

SEA1CM00044

3.4.2 Self-Consumption Mode

When there is sufficient solar power, the electric energy generated by the PV system will first be used to power the loads, with any excess energy being stored in the batteries. If there is still surplus energy, it will be sold to the grid. When there is insufficient solar power, the batteries will release electric energy to loads. By increasing the self-consumption ratio of the PV system and improving the self-sufficiency ratio of household energy, you can effectively save on your electric bills.

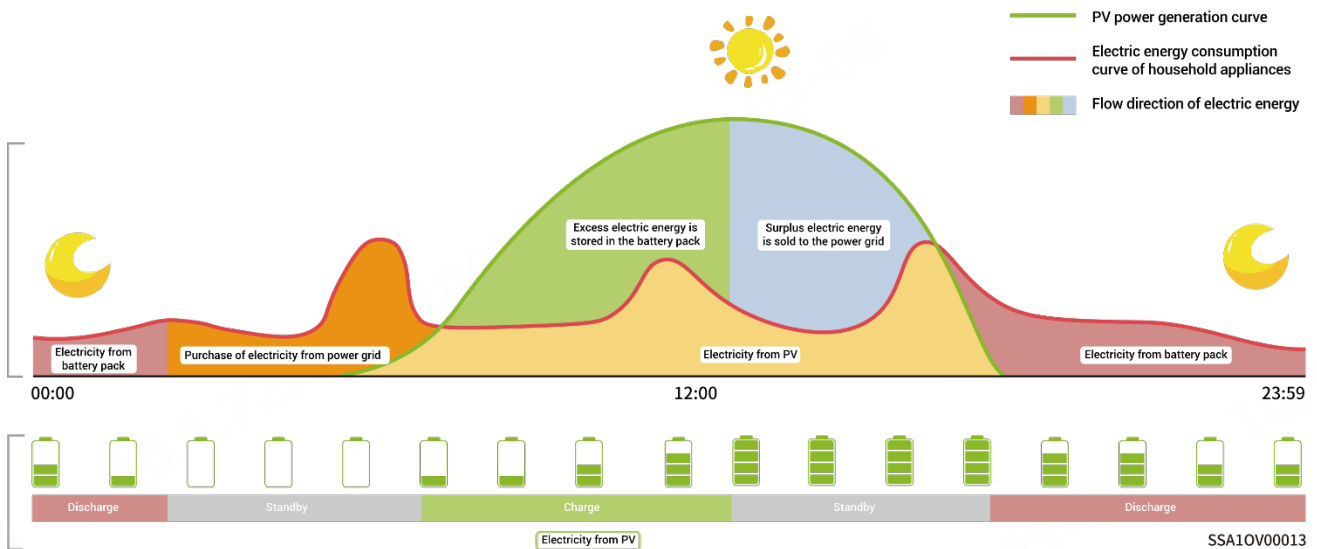

The electricity bill in some regions is calculated as follows: Total electricity bill = Cost at peak power + cost for electricity usage + other costs. Wherein, peak power refers to the maximum power imported from the grid. You can set the maximum peak power imported from the grid to reduce the electricity bill.

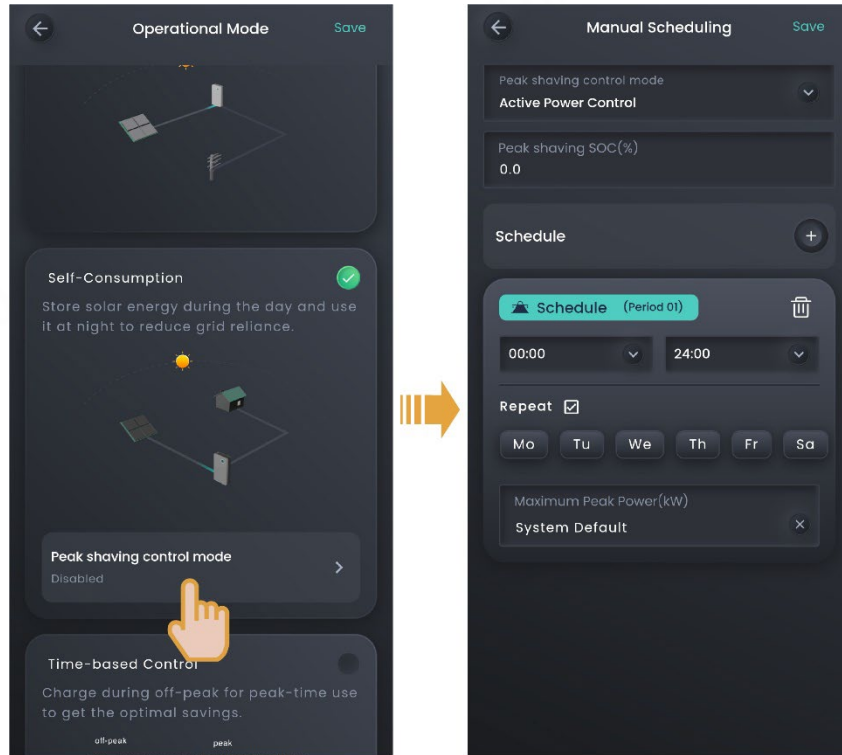

SEA1CM00045

No.	Parameter name	Description
1	Peak shaving SOC	<ul style="list-style-type: none"> When the household load is lower than the maximum peak power, the grid charges the battery pack until the battery capacity reaches the end-of-charge SOC setting. When the household load is greater than the maximum peak power, the battery pack supplies power to the load such that the power imported from the grid is equal to or lower than the maximum peak power.
2	Maximum Peak Power	Sets the maximum peak power imported from the grid for household load and charging the battery pack.

3.4.3 Time-based Control Mode

In Time-based Control mode, you must manually set the charging and discharging periods in the mySigen App, and the remaining periods will be non-charging and non-discharging periods. In the daytime, the surplus PV power can be sold to the grid or used to charge batteries. At night, batteries are charged from the grid when the electricity price is low to save the electricity bill.

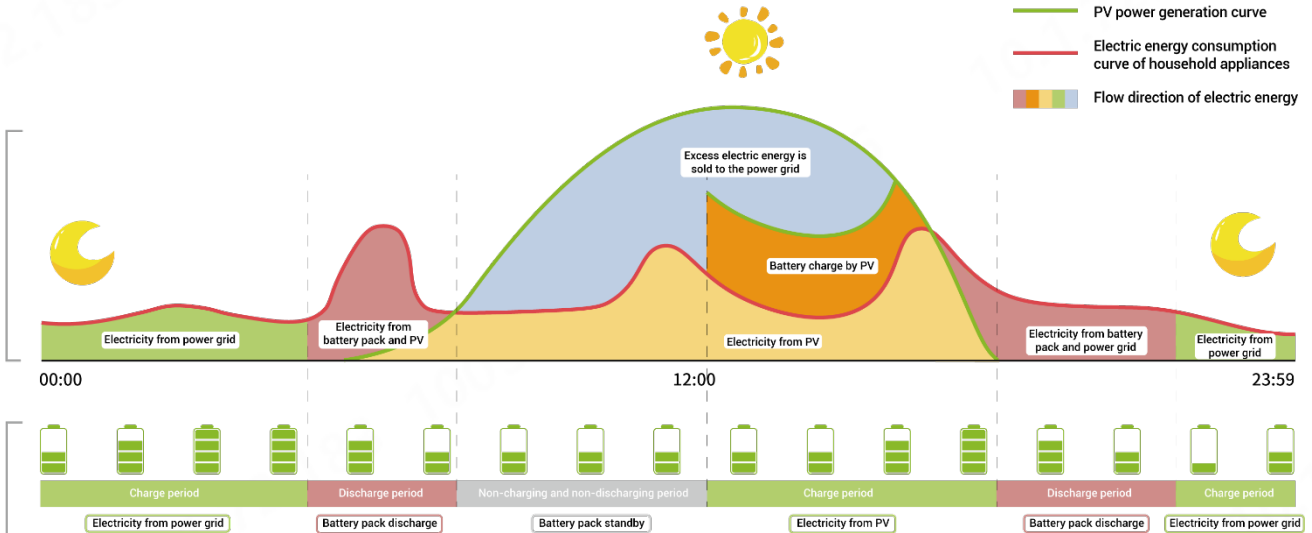

SSA10V00012

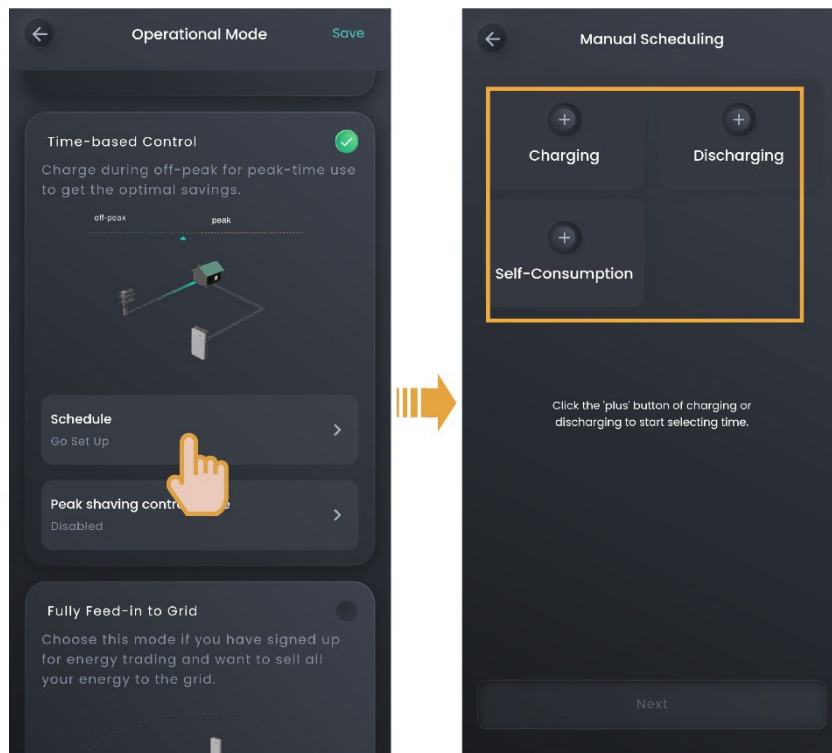

SEATCM00046

No.	Parameter name		Description
1	Charging	Maximum charging power for BAT	Sets the maximum charging power of the battery pack during this period.
2		Grid Charging Cut-off SOC	Sets the end-of-charge capacity of the battery pack during this period.
3		Maximum power for importing from grid	Sets the maximum power that can be imported from the grid during this period.
4		Maximum Charging Power from Grid to BAT	Sets the maximum power that the grid charges the battery pack during this period.
5	Discharging/ Self-Consumption	Maximum discharging power for BAT	Sets the maximum discharge power of a battery pack during this period.
6		Maximum power for exporting to grid	Sets the maximum power that the system can export to the grid during this period.
7		Maximum Discharging Power from BAT to Grid	Sets the maximum power that a battery pack discharges to the grid during this period.

Tips

The system will operate based on the PV power situation in periods that you do not specify as charging and discharging periods. The PV power will first be used to power home loads, with excess energy charging the batteries, and the batteries will not discharge.

The electricity bill in some regions is calculated as follows: Total electricity bill = Cost at peak power + cost for electricity usage + other costs. Wherein, peak power refers to the maximum power imported from the grid. You can set the maximum peak power imported from the grid to reduce the electricity bill.

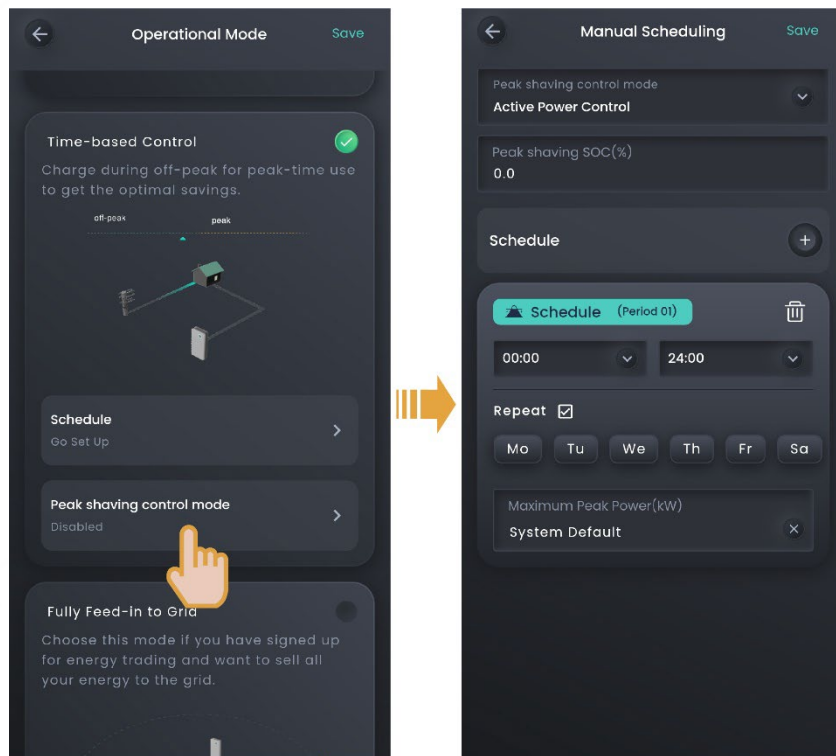

SEA1CM00046

No.	Parameter name	Description
1	Peak shaving SOC	<ul style="list-style-type: none"> When the household load is lower than the maximum peak power, the grid charges the battery pack until the battery capacity reaches the end-of-charge SOC setting. When the household load is greater than the maximum peak power, the battery pack supplies power to the load such that the power imported from the grid is equal to or lower than the maximum peak power.

No.	Parameter name	Description
2	Maximum Peak Power	Sets the maximum peak power imported from the grid for household load and charging the battery pack.

3.4.4 Fully Fed to Grid

You can sell excess energy back to the grid and earn credits on your energy bill. In the daytime, when the PV power is greater than the maximum output capacity of the inverter, the inverter maintains the maximum output while storing excess energy in the batteries. When the PV power is lower than the maximum output capacity of the inverter or there is no PV power in the nighttime, the batteries are discharged to ensure that the inverter maximizes the output.

3.5 Backup power setup

Tips

- **Skip this section if no Gateway is configured.**
- **Users can manually set this parameter according to the power interruption frequency of their regions and leave time.**

If there is a gateway in your networking, you can manually set the "Backup Reserve" value in the mySigen App. In grid connection mode, the battery stops discharging when the backup power SOC setting is reached. In the event of grid power outage, the backup power becomes available.

For example, the backup power SOC is set in Self-Consumption Mode.

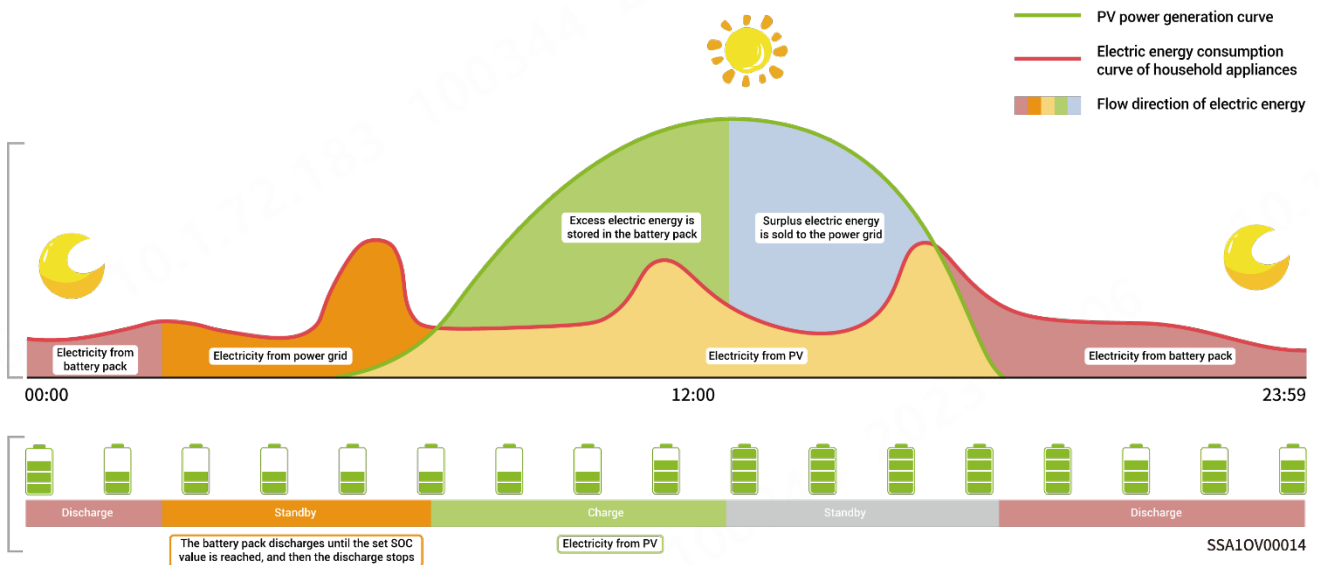

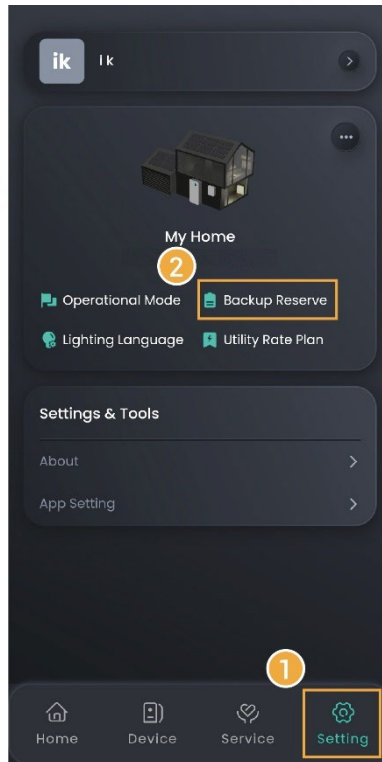

SSA1CM0007

3.6 Internet connection

Click "Setting" →  → "Connectivity" to go to the related screen.

No.	Parameter name	Description
1	Ethernet	Displays the connection status of Fast Ethernet. Do not disconnect the network cable when the Internet connection is stable.
2	WLAN	Displays the connection status of WLAN. Here you can configure the WLAN for all devices in the power station. <ul style="list-style-type: none"> ● Before configuring the WLAN, please make sure that antennas are installed on devices. ● Non-encrypted WLAN is not recommended as it may lead to Internet access failure. ● When WLAN is the only connection path for the devices to access the internet, switching WLAN to any other wireless router will be prohibited.
3	Cellular	Displays whether the 4G network is connected to Internet.

Tips

It is recommended to use Fast Ethernet and WLAN for communication with inverters. There may be charges for using 4G data.

3.7 LED status setup

The LED status can be set using the following two methods:

Method 1: Click "Home" → "Lighting".

Method 2: Click "Setting" → "Lighting Language".

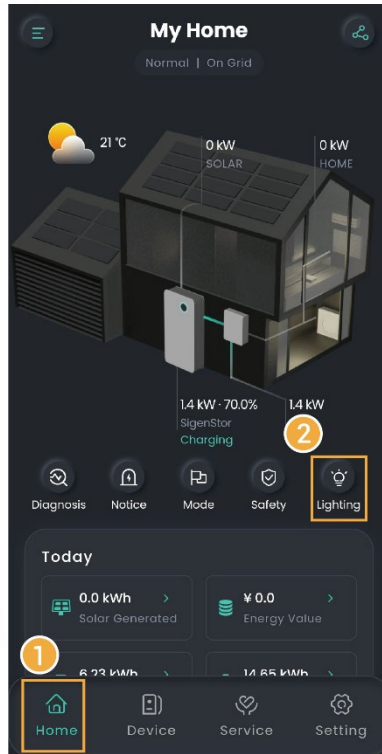

SSA1CM00003

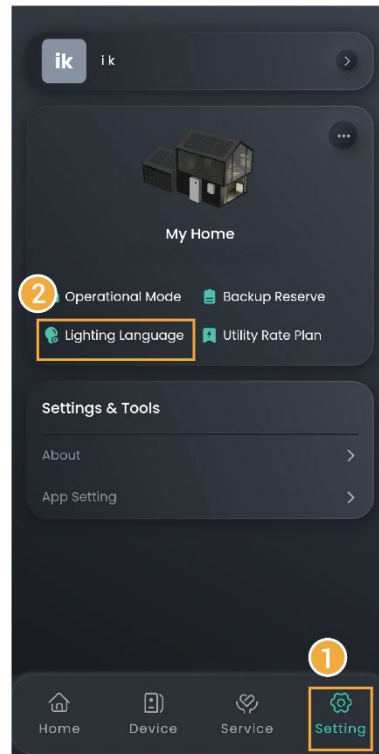

Tips

When it is set to , you can set the lighting effect according to your preference. When "LED Strips" is set to "Power Flow", the flowing water lighting effect from the top down indicates that the battery pack and charger are charging and the flowing water lighting effect from the bottom up indicates that the battery pack and charger are discharging. The steady-on lighting effect indicates that the battery pack and charger are not charging or discharging.

3.8 On-grid/Off-grid switchover

Tips

Skip this section if no Gateway is configured.

Danger

- **When set to "Go-Off-Grid," your inverter supports off-grid operation. During off-grid operation, the anti-islanding function of the inverter will be turned off.**
- **Before you perform any operation of the power distribution system (such as installation, wiring, or replacement), ensure that all power supplies and their corresponding circuit breakers are disconnected. This includes the power switches of the power grid side, inverter and diesel generator to avoid operation with power on.**

Method 1: Click "Setting" → .

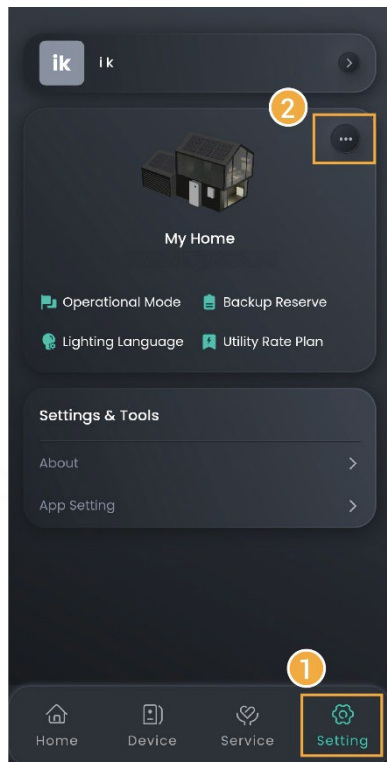

SSA1CM00007

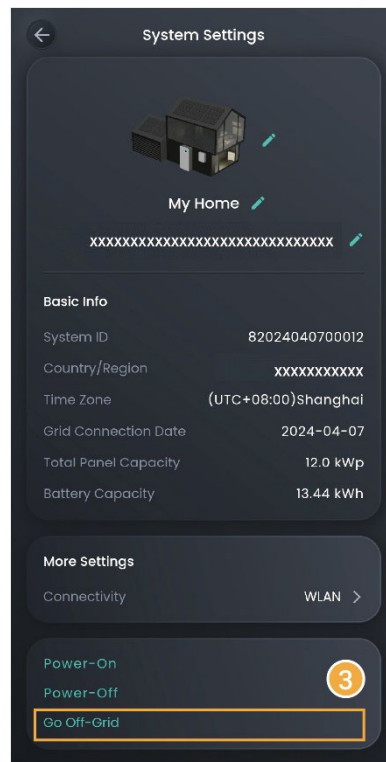

Method 2: Click "Home" → **Gateway** product picture.

Method 3: Click "Device" → **Gateway**.

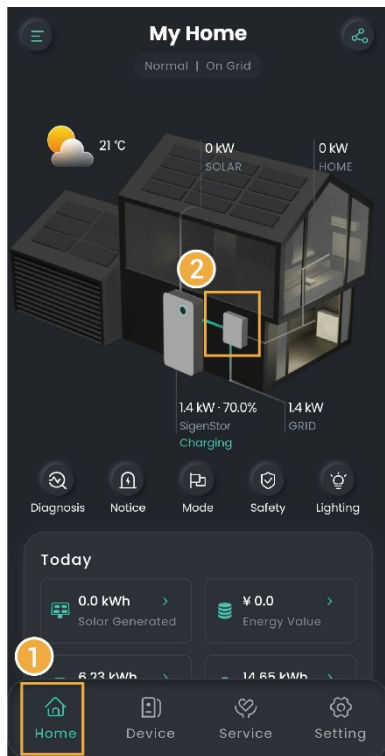

SSA1CM00003



3.9 Adding device

Tips

- **If you use our products, the system will automatically recognize and connect them. You can view device information on the "Device" screen.**
- **This section describes how to connect a third-party device.**

3.9.1 Third-party inverter

Tips

Before connecting to a third-party inverter, make sure that:

- **The third-party inverter is properly connected to an electric meter which is purchased from our company.**
 - **The electric meter is properly connected to the COM port of our inverter.**
- For connection ports, please refer to the respective Installation Guide.**

Figure 1. Diagram of third-party inverter wiring connections

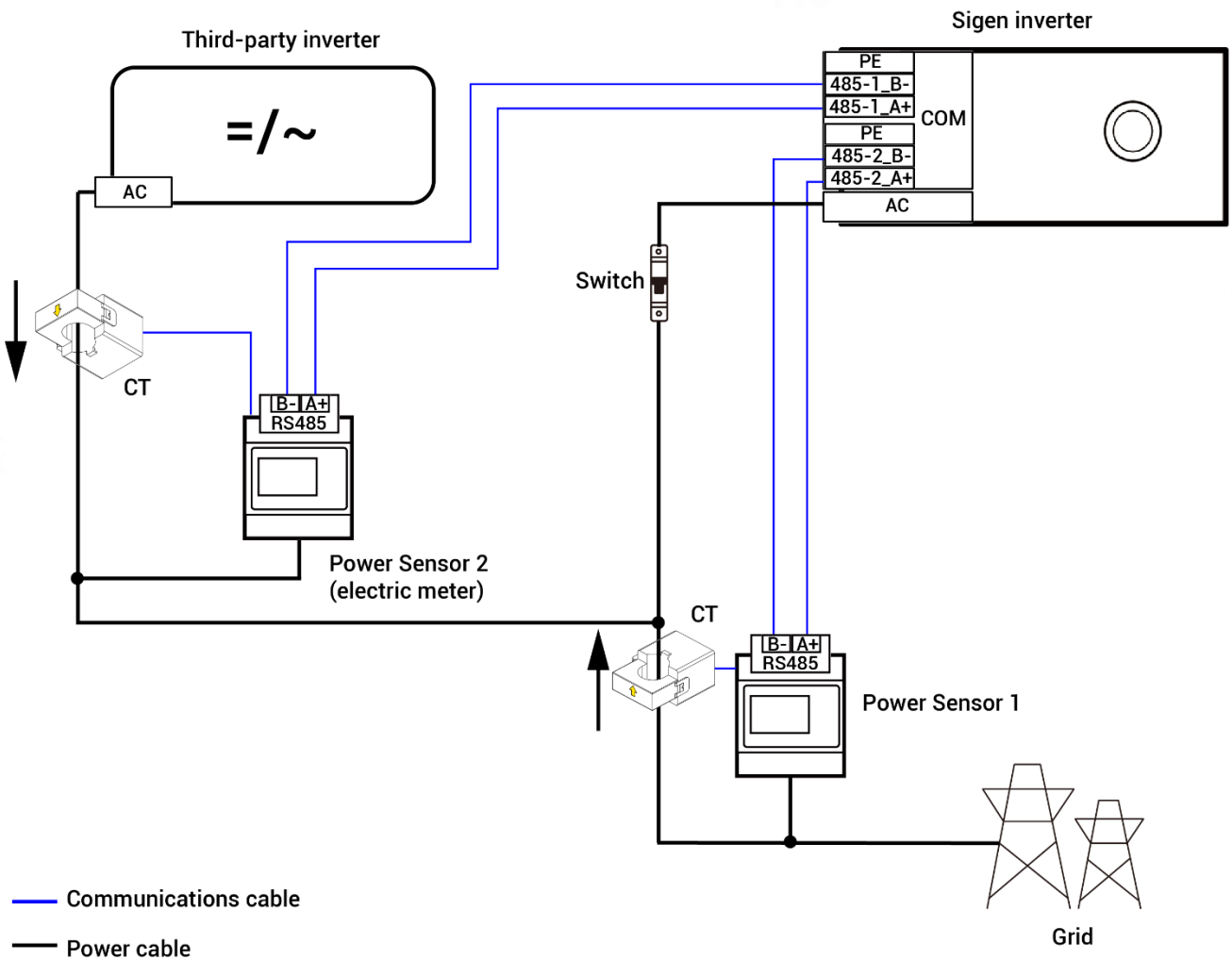

MSA1CM00051

The diagram displays the connections among different cables of equipment. The specific ports shall be determined by actual equipment.

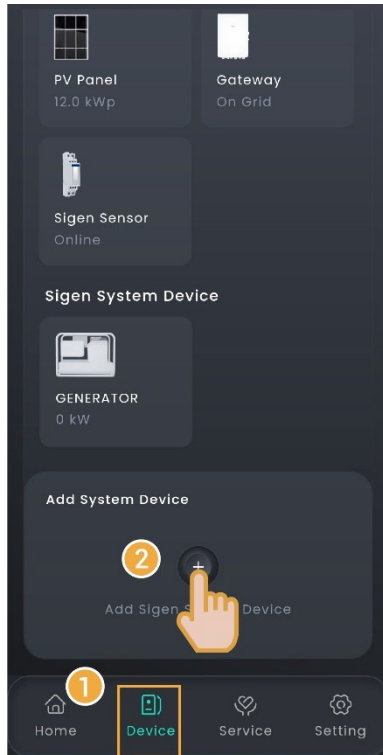

SSA1CM00005

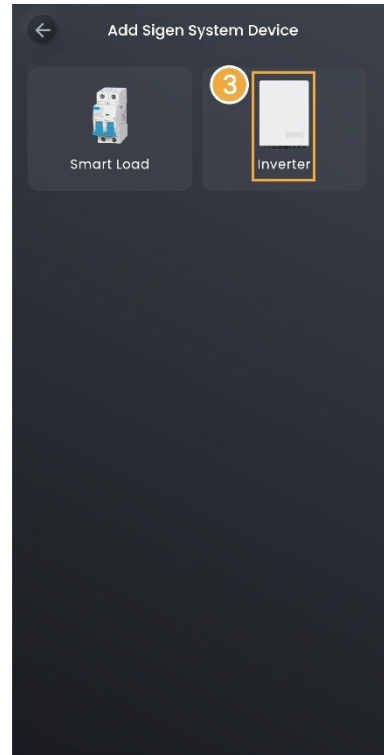

On the "Device" screen, set related parameters based on the third-party inverter and the connected meter. Then, you can check detailed settings on the "Device" screen.

3.9.2 Diesel generator

Tips

Before connecting a diesel generator, please ensure that the Gateway that can be connected to the diesel generator has been configured in the networking and connected correctly. For details about the Gateway, please refer to the respective Installation Guide.

The system can automatically recognize and connect the diesel generator. Check the details and make settings in "Device" → "GENERATOR".

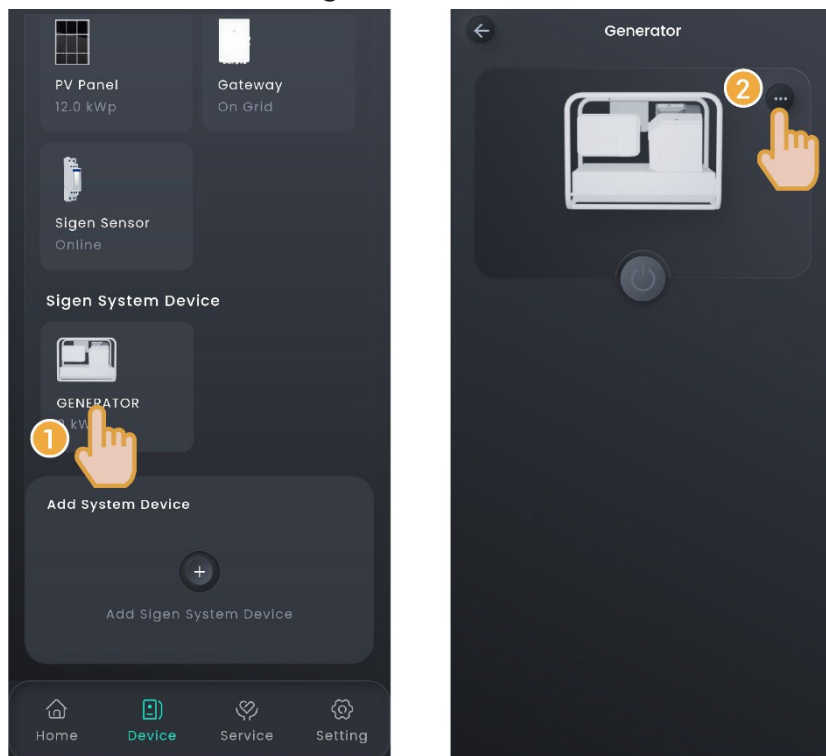

SSA1CM00048



Manual start by operating the generator's switch

In this mode, you must switch on and off the system on the generator side.

No.	Parameter name	Description
1	Rated Power	Sets the rated power of the diesel generator.
2	Best Power Duty	To guarantee the optimal functioning status of the system, you are advised to control the output power of the diesel generator not more than 80%.

two - wire - start

In this mode, you can start and stop the diesel generator in the App, or the diesel generator can start or stop automatically.

No.	Parameter name	Description
1	Operating Mode	<ul style="list-style-type: none"> ● Manual ● Auto
2	Generator Start	In "Manual" mode, when it is set to  , you can start or stop the diesel generator using the  icon in the App.
3	Rated Power	Sets the rated power of the diesel generator.
4	Best Power Duty	To guarantee the optimal functioning status of the system, you are advised to control the output power of the diesel generator not more than 80%.
5	Time of Use	In "Auto" mode, set the time period and SOC threshold for automatic power-on/off of the diesel generator.

3.9.3 Smart load

Tips

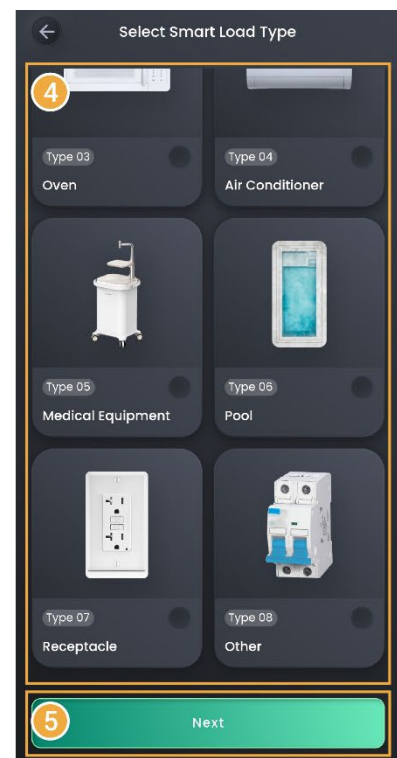
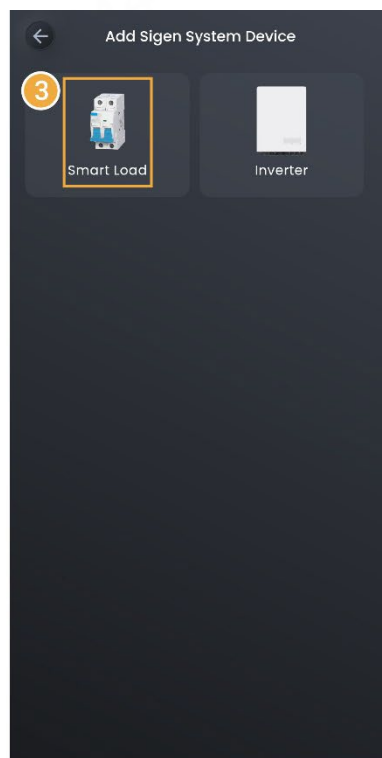
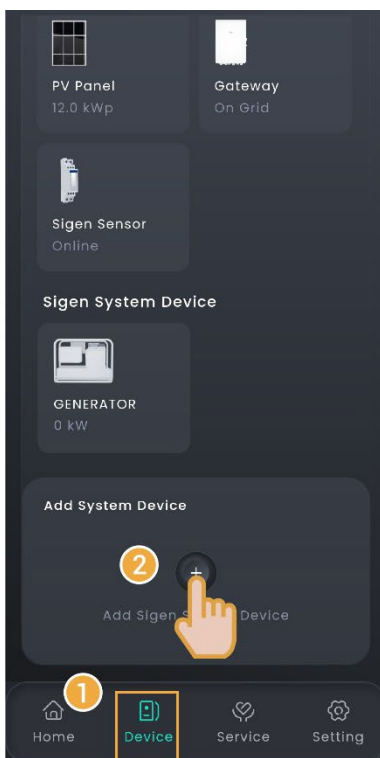

- **Before connecting a smart load, please ensure that a Gateway is configured in the networking.**
- **The number of smart loads that can be connected is determined by the supported capacity of the Gateway.**
- **After adding the smart load to the App, you can switch the smart load on and off through the App. Alternatively, the system can remotely control the equipment on and off based on the actual running conditions and the SOC threshold you set.**



SSA1CM00005

If you cannot locate the icon of the connected device, for example, an immersion heater, select "Other" and connect it. You can check the connected smart load on the "Device" screen.

Operating Mode

No.	Parameter name		Description
1	Manual		When "Manual" is set to  , you can power on and off smart loads using "  " in the App.
2	Auto	SOC	When it is set to  , you can control the power-on/off of smart loads using SOC.
3		SOC Threshold for Load Activation	Sets the SOC threshold for power-on/off of smart loads. The load powers on when the actual value is greater than the set threshold and powers off when the actual value is lower than the set threshold.
4		Time of Use	Sets the time period for controlling power-on/off of smart loads using SOC.

3.10 Device power-on/off

Batch power-on/off

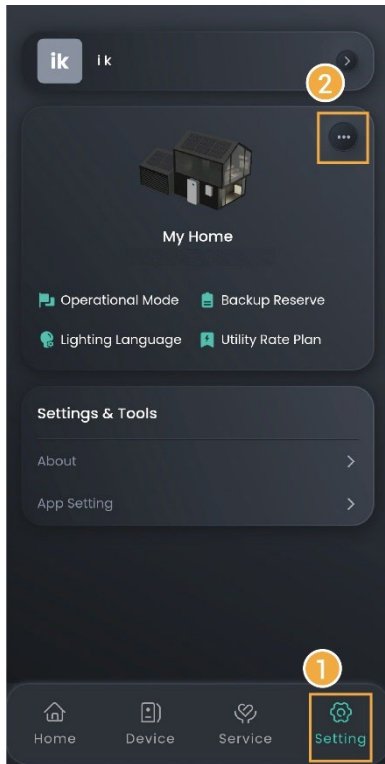

SSA1CM0007

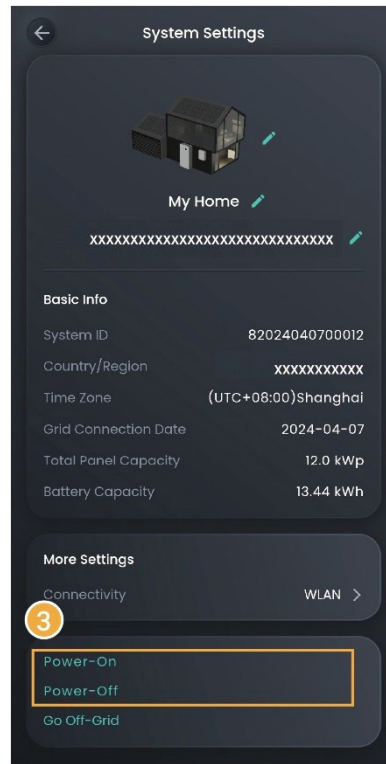

Power-on/off of a single device

In the corresponding device area on the "Device" screen, click the related button or go to the "Setting" screen to make settings.

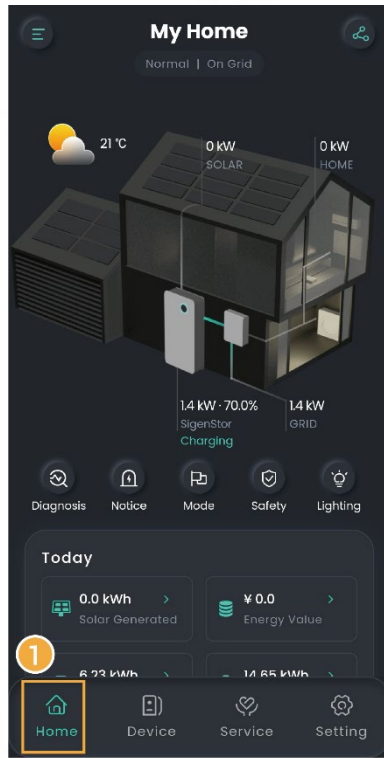

SSA1CM00003

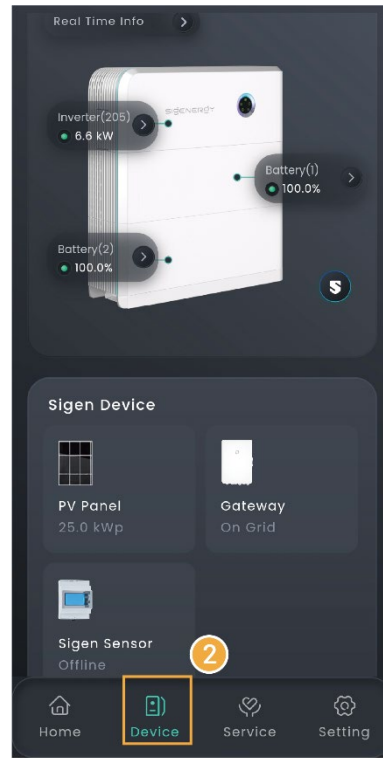

3.11 Sigen EV AC Charger Parameters

Tips

This document provides only the ways to set parameters. For equipment use, please refer to the Sigen EV AC Charger User Manual.

3.11.1 Binding RFID card

Go to "Setting" → "Card Management", and bind a RFID card.

3.11.2 Charging/Stop Charging Settings

- **Manual Start/Stop From App**

On the "Home" page, click "START" or "STOP".

- **Unauthenticated Charging Mode**

On the "Setting" screen, set "Authorization" to .

Tips

It should be noted that when the unauthenticated charging mode is enabled, any vehicles can use this equipment for charging.

3.11.3 Charging Current Adjustment

Tips

The higher the output current is, the higher the charging power is.

Manual adjustment

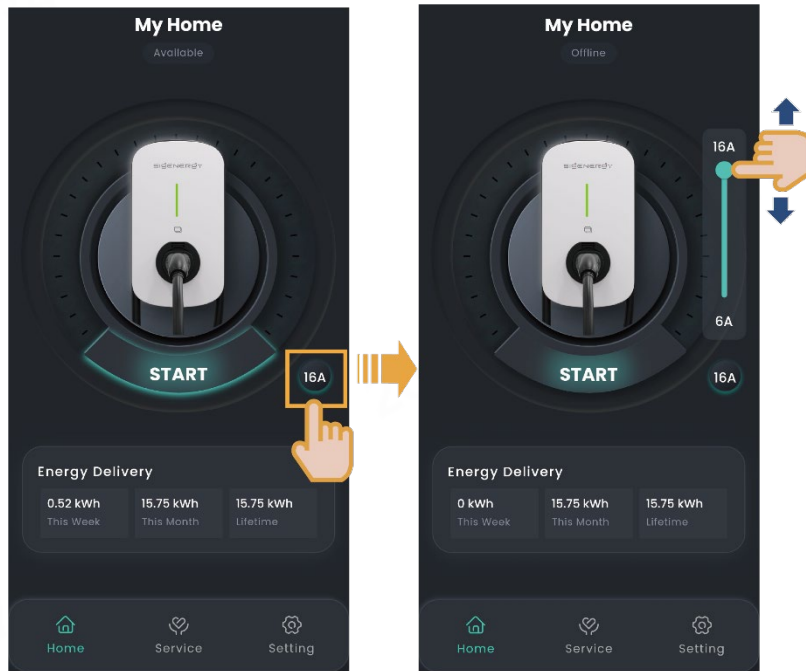

SEA1CM00003

Automatic adjustment of DLM

Tips

You must install a Power Sensor in the networking.

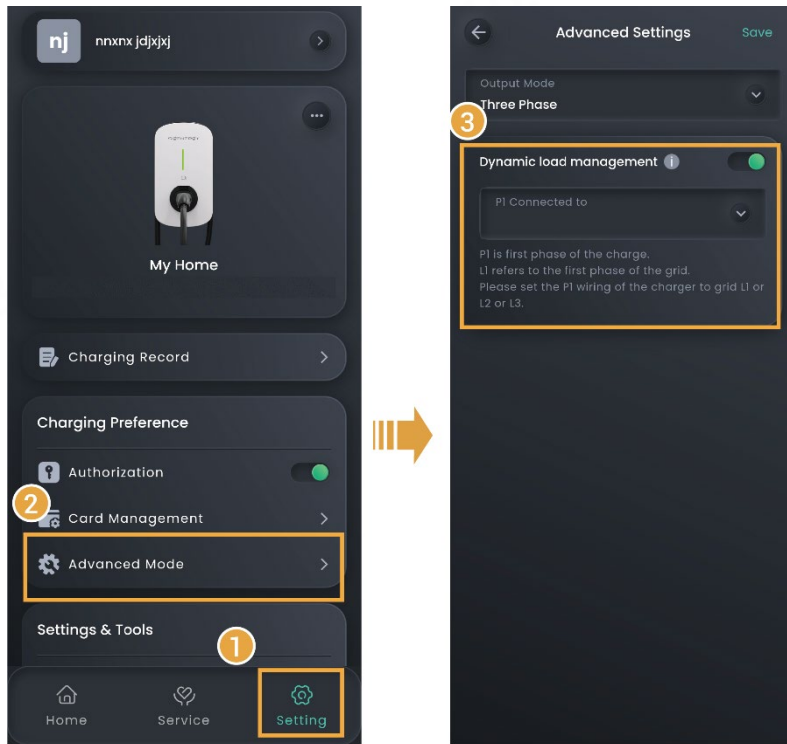

MSA1CM00038

3.11.4 Modifying output mode

The system automatically recognizes the output mode when you create new systems. If the AC cable connection method changes after you create new systems, please modify "Output Mode" accordingly in the App.

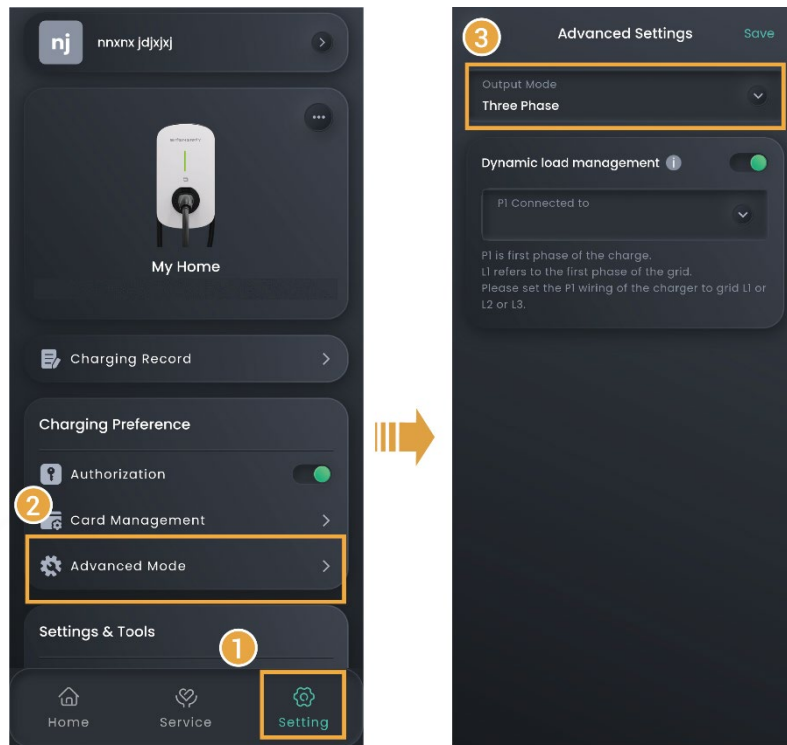

MSA1CM00038

3.12 App Parameters

3.12.1 Upgrading mySigen

Tips

To gain the best compatibility and performance, you are advised to upgrade the mySigen App regularly.

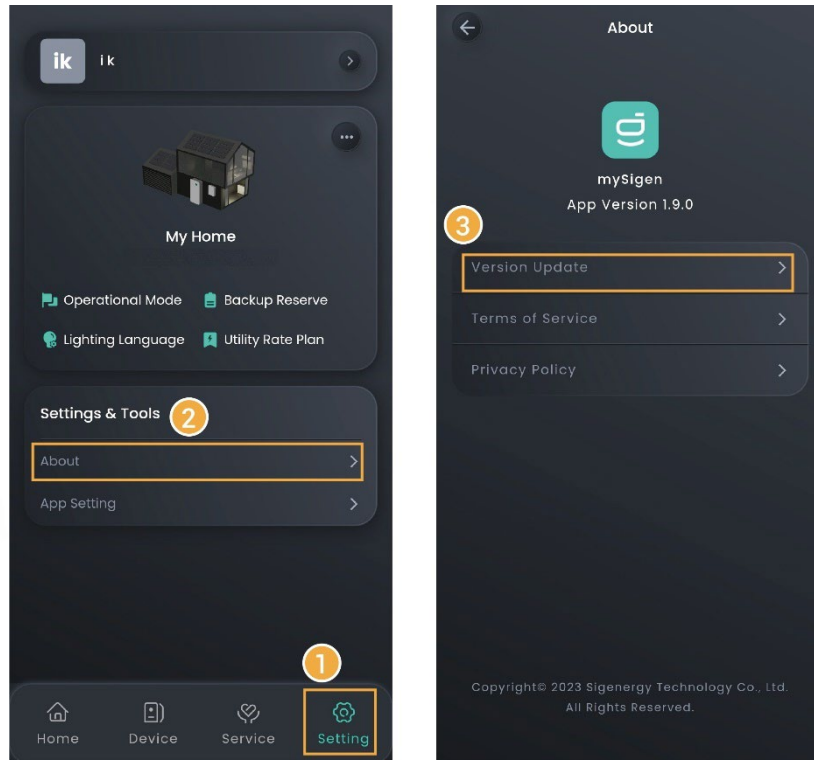

SSA1CM00007

3.12.2 Changing password

On the login screen, click "Forgot Password" to reset the login password.

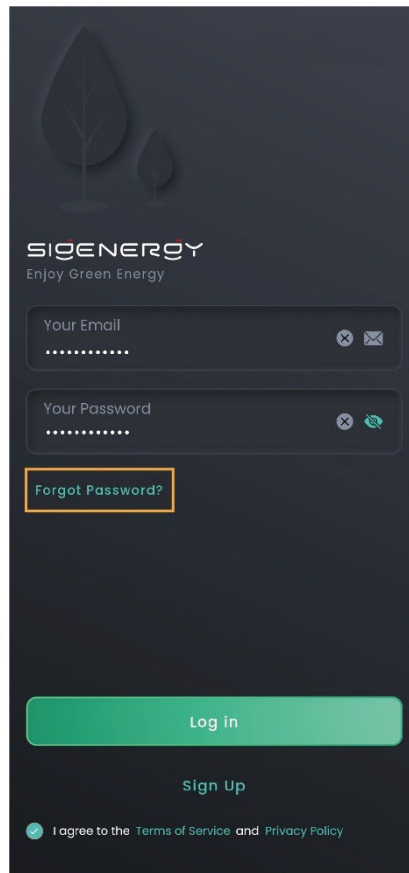

SSA1CM00016

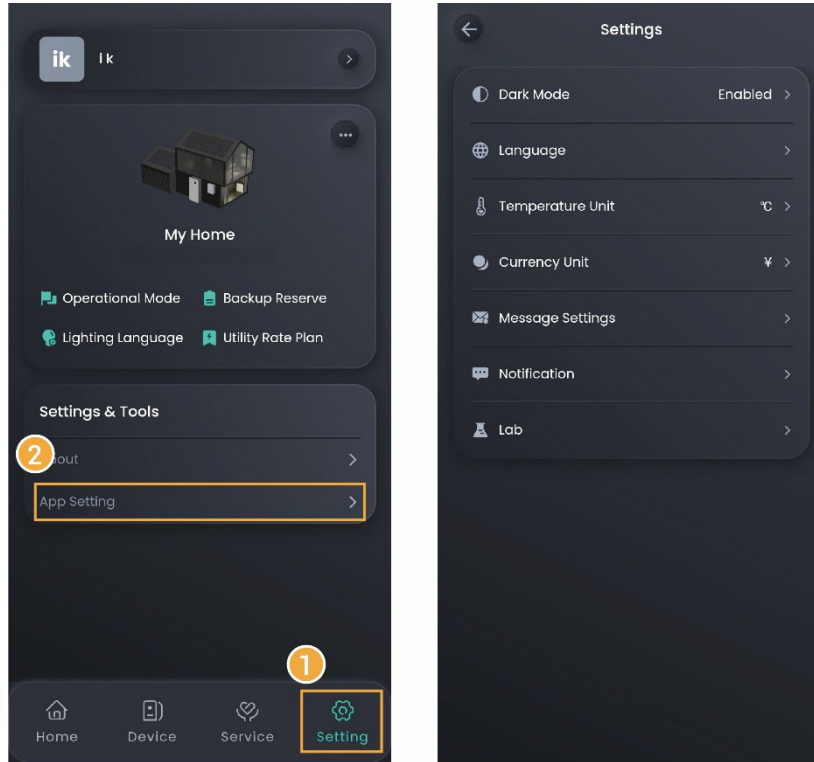

3.12.3 Configuring parameters on the "App Setting" screen

Settable parameters on the "App Setting" page vary with equipment. The actual screen shall prevail.



SSA1CM0007

No.	Parameter name	Description
1	Dark Mode	Sets the display style of the App.
2	Language	Sets the display language of the App.
3	Temperature Unit	Sets the unit of temperature. The unit of temperature commonly used in the local area is set in the App by default. You can change this setting when needed.
4	Currency Unit	Sets the unit of currency. The unit of currency commonly used in the local area is set in the App by default. You can change this setting when needed.
5	Message Settings	Sets the message notification permission. There will be a prompt message on the "Messages" on the "Service" page when the parameter is set to

No.	Parameter name	Description
		
6	Notification	Sets the App push notification permission. This permission is set while the App is installed. You can make settings when needed.
7	Lab	Sets the access permission of Sigen AI. You can ask Sigen AI about the product knowledge when the parameter is set to  .

Chapter 4 Switch Accounts

The App enables you to quickly switch among accounts when you have set multiple accounts for different products.

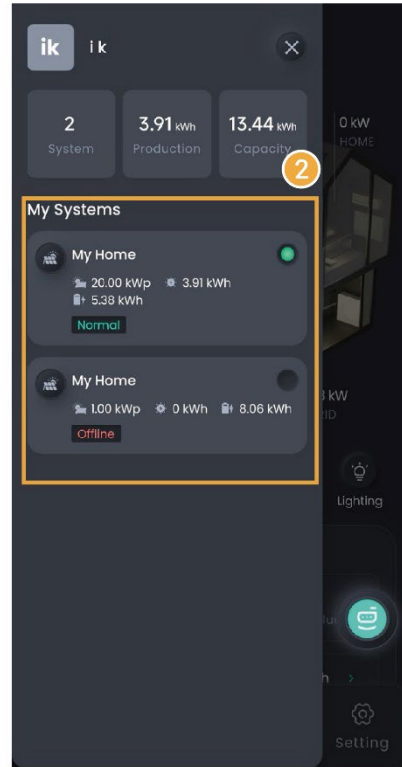
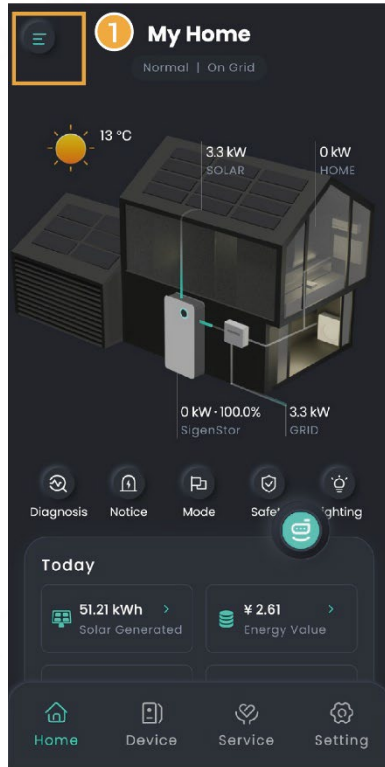

MSA1CM00040

Chapter 5 Changing Email

Account

You can change the bound email account in the App by performing the following operation on the screen.

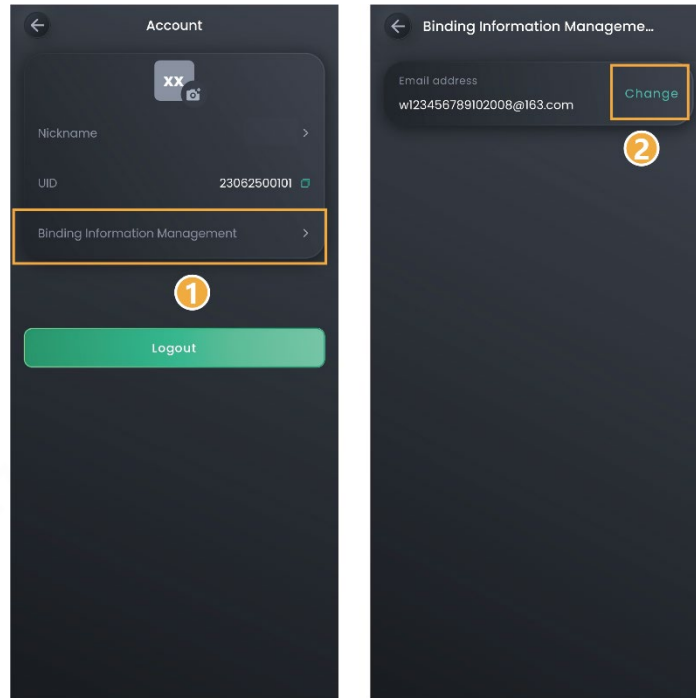

SSA1CM00013

Chapter 6 Support

Please feel free to reach out to us in the App if you have any questions about the use of the product.

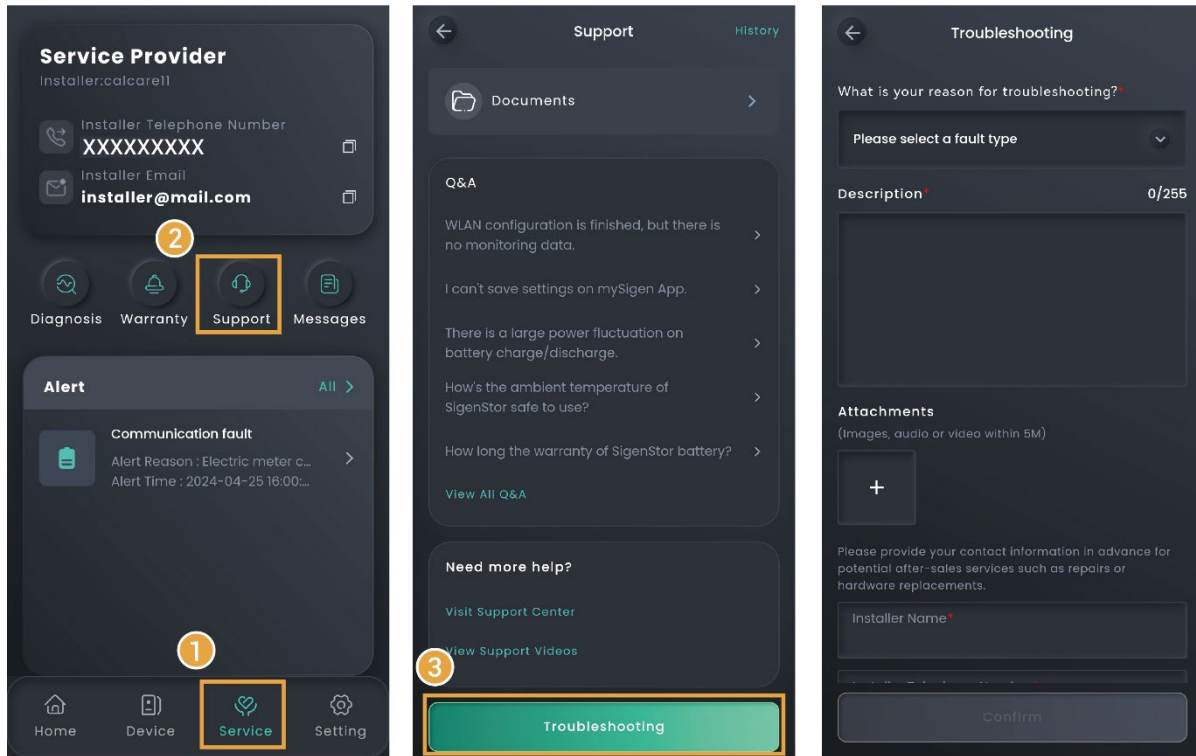

MSA1CM00039

Tips

To check the question history, click "History" in the upper right corner of the "Support" page.

Chapter 7 Logout

Click "Setting" → profile photo → "Logout".

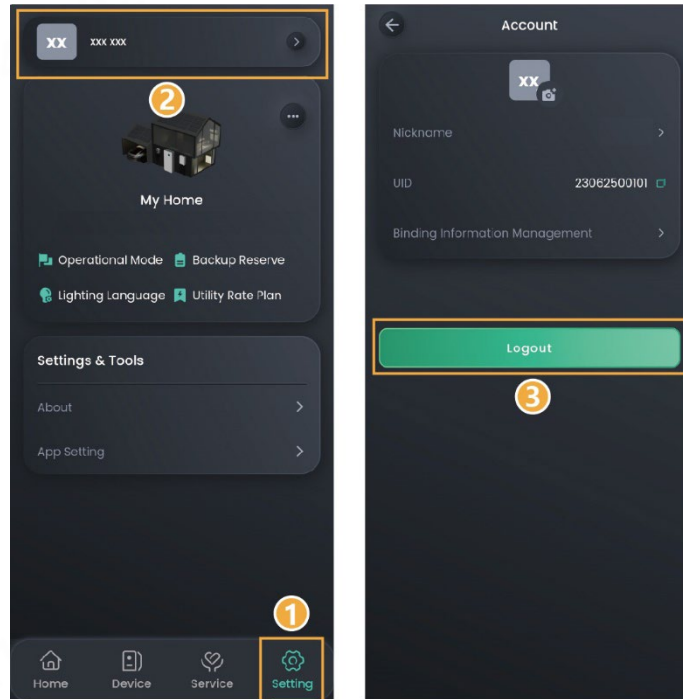

SSA1CM00013

Chapter 8 FAQs

8.1 What should I do if I do not receive the email (link, password change) sent by the system?

- Check whether the email from the "sigencloud" account was received in the Spam folder
- Push the notification again

8.2 In grid connection scenarios, how can I quickly identify where SigenStor is installed?

You can light up the LED of SigenStor in the App and locate the SigenStor.

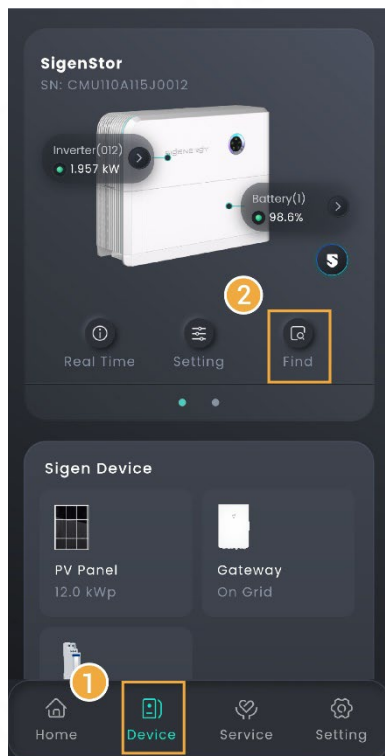

MSA1CM00043

